

HSF

NOTES:

1. Insulator material: PA9T+33%G.F, UL94 V-0;
2. Terminal material: Copper Alloy;
Terminal Plating: Au/Sn Plated Over Nickel ;
3. Rated Voltage: Power 600V;
4. Rated Current: Power 30A;
5. Contact Resistance:
Power 0.7mΩ Max;
6. Insulation Resistance: DC500V
Power 10000MΩ Min;
7. Insulation Withstand Voltage:
Power 2500VAC/1min;
8. Durability :200 cycling;
9. Operation Temperature: -20°C to +105°C;

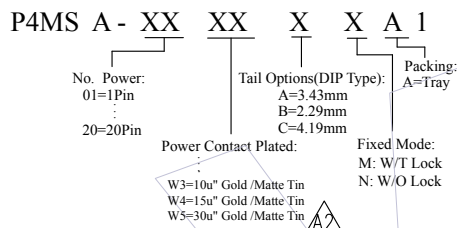

Product Data Sheet

No.	P/N	No. Power	DIM "A"	DIM "B"	DIM "C"	DIM "F"
1	P4MSA-14XXXXA1	14	105.4	97.79	96.52	101.17
2	P4MSA-10XXXXA1	10	80.01	72.39	71.12	75.77
3	P4MSA-08XXXXA1	8	67.31	59.69	58.42	63.07
4	P4MSA-07XXXXA1	7	60.96	53.34	52.07	56.72
5	P4MSA-06XXXXA1	6	54.61	46.99	45.72	50.37
6	P4MSA-05XXXXA1	5	48.26	40.64	39.37	44.02
7	P4MSA-04XXXXA1	4	41.91	34.29	33.02	37.67
8	P4MSA-03XXXXA1	3	35.56	27.94	26.67	31.32
9	P4MSA-02XXXXA1	2	29.21	21.59	20.32	24.97

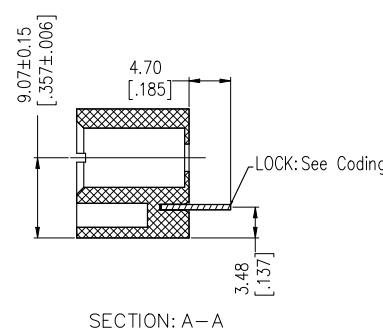
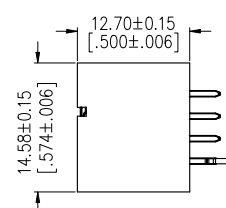
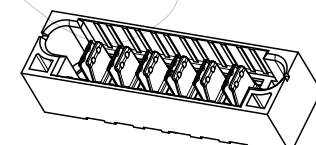
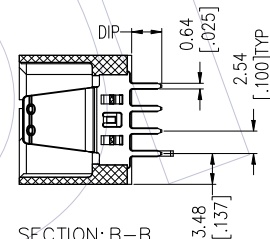
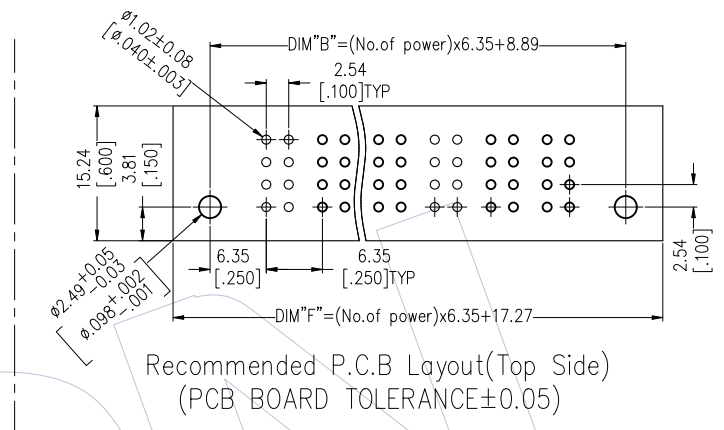
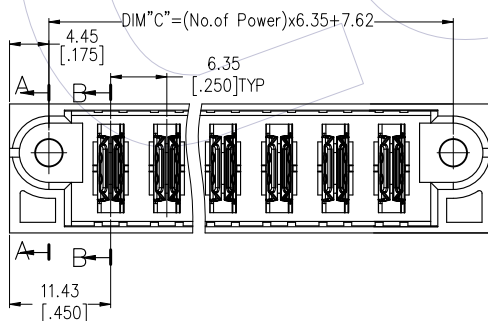
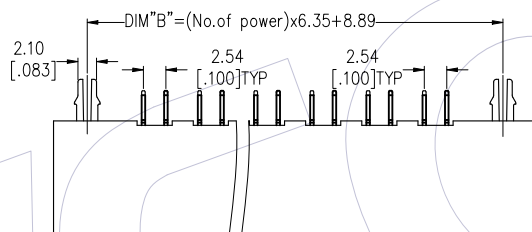
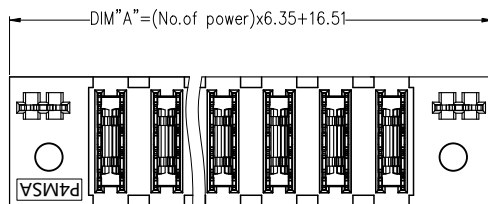

REV	DATE	MODIFICATION DESCRIPTION	CHANGE	OPERATION	DRAW	DATE	SCALE	FIT	PART NO.
A2	2024/09/04	Cancel Xu"Gold/Tin Plated	XSR	x.x ±0.40	XSR	2024/09/04	UNIT	mm	P4MSA-XXXXXA1
A1	2022/03/28	Modify Notes	---	x.xx ±0.25	CHECK	DATE	SIZE	A4	
A0	2018/10/15	NEW	---	x.xxx ±0.15	APPROVE	DATE	SHEET	1/1	TITLE: PSP Spacing A 180' DIP MALE (TYPE-4:Power)
REV	DATE	MODIFICATION DESCRIPTION	CHANGE	Angle ± 3° DIM TOL		DATE	PROJ.		

Http: www.wcon.com

WCON-Dongguan	WCON-Kunshan
Tel: +86 769 85358920	Tel: +86 512 57468408
Fax: +86 769 85358915	Fax: +86 512 57468468
E-mail: sales@wcon.com	E-mail: salesks@wcon.com